

Data Sheet



Article number: 03704020

Description: Fluro rod end BRM 20
with ball bearing

Measures

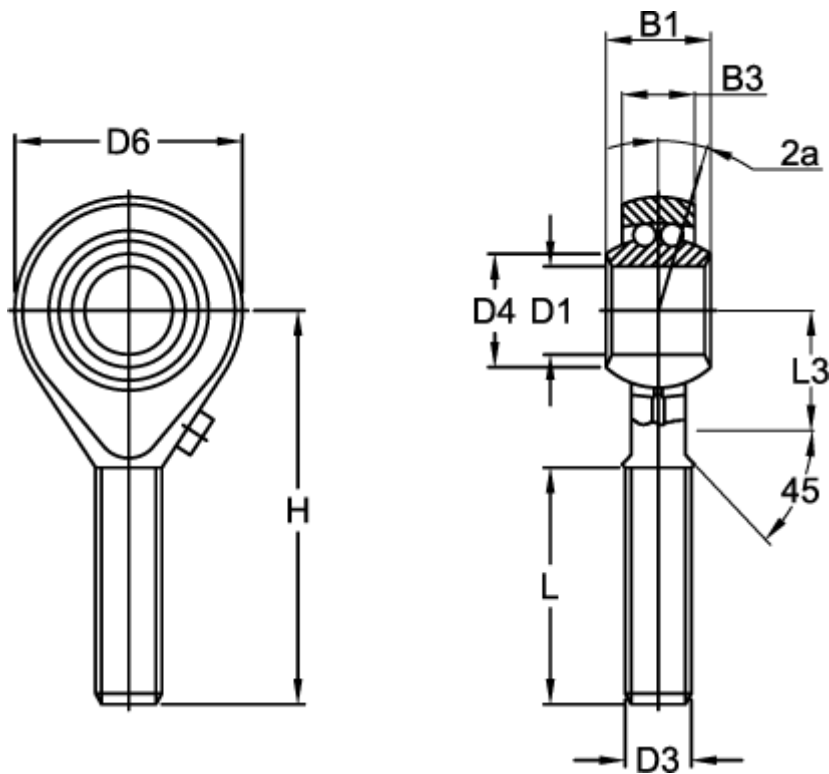

Angel 2a	= 7.0	H	= 78
B1	= 25	L	= 47
B3	= 18.00	L3	= 28
D1	= 20	Max rpm	= 825
D3	= M20x1,5	Static load (N)	= 3450
D4	= 24.5	Weight (kg)	= 0.338
D6	= 50		
Dynamic load C (N)	= 7900.0		